

ELECTRIC GUITAR AEX-500NS

SERVICE MANUAL



WARNING : CHEMICAL CONTENT NOTICE!

The solder used in the production of this product contains LEAD. In addition, other electrical/electronic and/or plastic (Where applicable) components may also contain traces of chemicals found by the California Health and Welfare Agency (and possibly other entities) to cause cancer and/or birth defects or other reproductive harm.

DO NOT PLACE SOLDER, ELECTRICAL/ELECTRONIC OR PLASTIC COMPONENTS IN YOUR MOUTH FOR ANY REASON WHAT SO EVER!

Avoid prolonged, unprotected contact between solder and your skin! When soldering, do not inhale solder fumes or expose eyes to solder/flux vapor!

If you come in contact with solder or components located inside the enclosure of this product, wash your hands before handling food.

CONTENTS

OVERALL ASSEMBLY	2
ELECTRICAL PARTS	4
CIRCUIT BOARD	5
CIRCUIT DIAGRAM	5
WIRING	6
SPECIFICATIONS	6

This document is printed on chlorine free (ECF) paper with soy ink.

EG 011590

20010910-60000



YAMAHA

HAMAMATSU, JAPAN

OVERALL ASSEMBLY

• Jack Installation

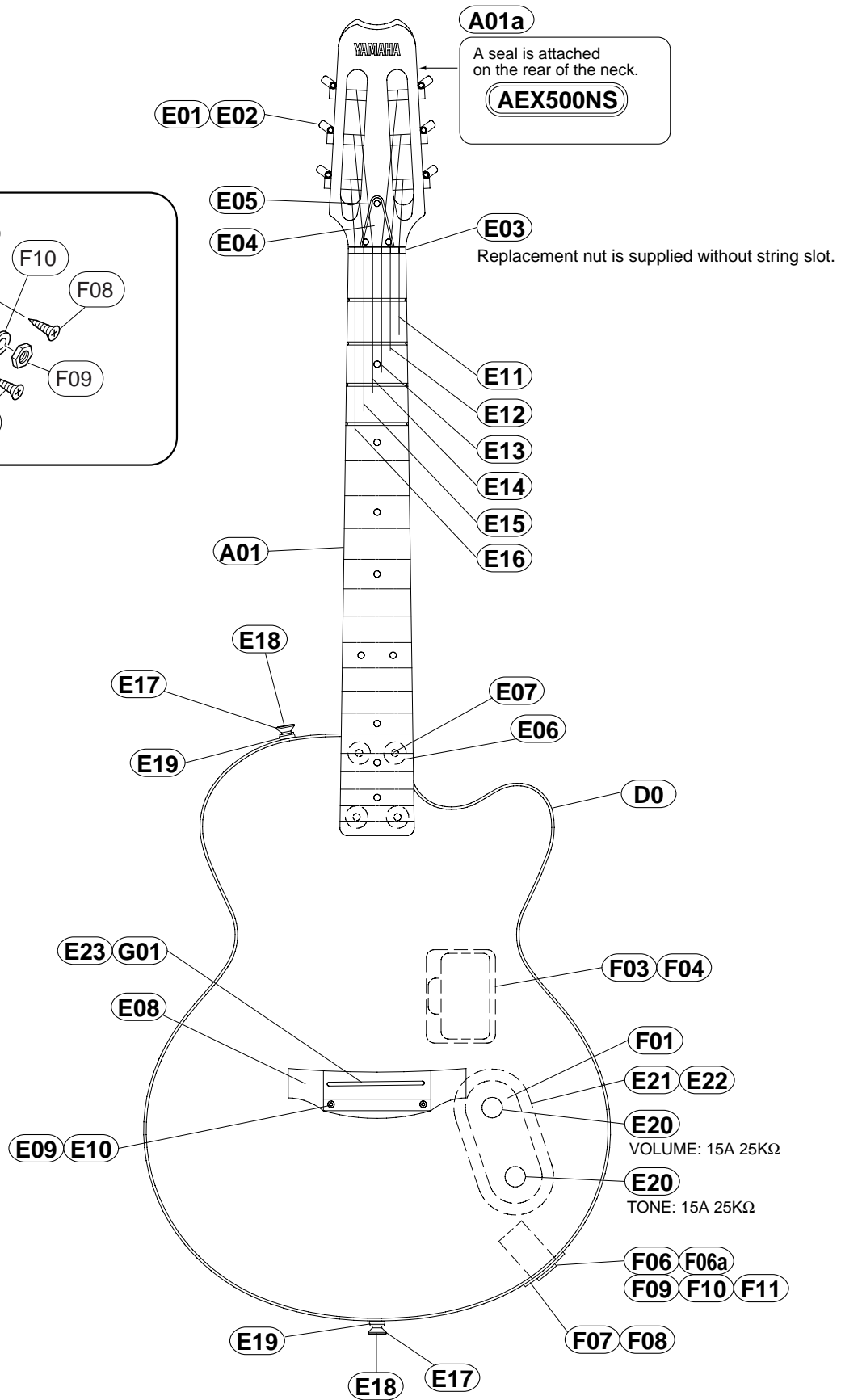
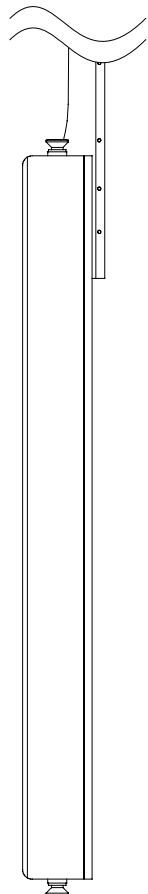
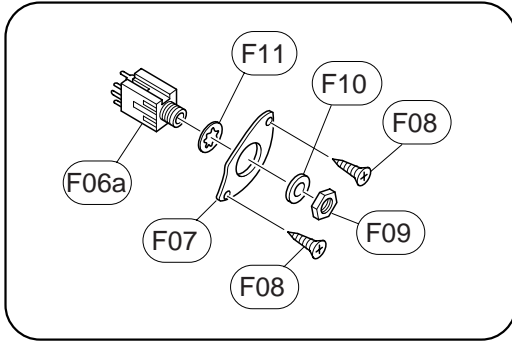

REF NO.	PART NO.	DESCRIPTION		REMARKS	QTY	RANK
* A01	AAX28830	OVERALL ASSEMBLY		AEX-500NS		
A01a	--	Neck Assembly Seal		(QC59570)		
D0	--	Body				
E01	QA170300	Tuning Machine Assembly	RM1258 (Gold)	1set		
E02	03714060	Round Head Wood Screw	2.1X8 (Brown)		8	01
* E03	QC603000	Nut	Bone 45mm			
E04	VQ011800	Rod Cover	Black			
E05	03706220	Oval Head Wood Screw	2.1X10 (Black)		3	01
* E06	QC205100	Neck Joint Bushing	Gold		4	
E07	EN240050	Oval Head Tapping Screw	4.0X45 (Gold)		4	
* E08	QC596700	Bridge				
E09	20454100	Oval Head Wood Screw	2.4X16 (Chrome)		2	01
E10	03377460	Cap	M5.0 (White)			01
E11	--	String	1 CG S11	1 (QA33300)		
E12	--	String	2 CG S12	2 (QA33310)		
E13	--	String	3 CG S13	3 (QA33320)		
E14	--	String	4 CG S14	4 (QA25310)		
E15	--	String	5 CG S15	5 (QA25320)		
E16	--	String	6 CG S16	6 (QA25330)		
E17	BB802460	End Pin	ST-type (Gold)		2	02
E18	EN230130	Oval Head Wood Screw	3.0X25 (Gold)		2	
E19	VB793700	Spacer Felt	Black		2	01
E20	QC466500	Wood Knob Assembly	M19 H=17.5		2	04
* E21	QC598200	Back Cover	Electrical (Black)			
E22	EB620020	Oval Head Wood Screw	2.7X13 (Black)		4	03
* E23	QC627400	Bridge Saddle	Bone 80mm			
* F01	QC595800	Circuit Board	AEX-500NS	Pre-amplifier with Battery Cord		
F03	QC399100	Box for Dry Cell				04
F04	QC025000	Pan Head Tapping Screw	3.0X8 (Black)		2	
F06	--	Electrical Unit (Jack)		(QC59810)		
F06a	LB201120	Jack				03
* F07	QC604500	Jack Panel	JCB-2 (Gold)			
F08	03706300	Oval Head Wood Screw	2.7X13 (Gold)		2	
F09	LX200050	Hexagonal Nut	9S (Gold)			02
F10	LX200040	Flat Washer	9S (Gold)			02
F11	ET800180	Toothed Lock Washer	9S		3	01
* G01	QC624400	Pickup Assembly	B-band 29S			
H01	QC354400	Accessory Unit	G-5	1set		08
	QA262600	Cord	D			05
	--	Wrench	#5 (L=95)			
H02	--	Battery	006P	(PC10008)		

*: New Parts

RANK: Japan only

ELECTRICAL PARTS

REF NO.	PART NO.	DESCRIPTION		REMARKS	QTY	RANK
*	QC595800	ELECTRICAL PARTS Circuit Board	AEX-500NS	AEX-500NS Pre-amplifier (QC61240)		
*	QC595800	Circuit Board	AEX-500NS	Pre-amplifier (QC61240)		
C01	UA155100	Mylar Capacitor	0.1uF			01
C02	UI137100	Electrolytic Cap.	10uF/16V			01
C03	UA155100	Mylar Capacitor	0.1uF			01
C04	FG411330	Ceramic Capacitor	33pF			01
C05	UI137100	Electrolytic Cap.	10uF/16V			01
C06	UI137100	Electrolytic Cap.	10uF/16V			01
C07	UA155100	Mylar Capacitor	0.1uF			01
C08	UI137100	Electrolytic Cap.	10uF/16V			01
* CN1	AAX28840	Connector	2P RE-H022SD-1190	to Pickup		
CN2	LB918020	Connector	2P	to Battery		01
CN3	LB918030	Connector	3P	to Output jack		01
D01	IF000040	Diode	1S1555			01
Q01	IE000010	FET	2SK30ATM			03
Q02	IE000010	FET	2SK30ATM			03
* R01	AAX28850	Carbon Resistor	10M			
R02	HF557100	Carbon Resistor	10K			01
R03	HF556470	Carbon Resistor	4.7K			01
* R04	HF555680	Carbon Resistor	680			
R05	HF559100	Carbon Resistor	1M			01
R06	HF557100	Carbon Resistor	10K			01
R07	HF556470	Carbon Resistor	4.7K			01
* R08	HF556270	Carbon Resistor	2.7K			
R09	HF558100	Carbon Resistor	100K			01
* VR1	QC612800	Variable Resistor	15A 25K ohm	VOLUME		
* VR2	QC612800	Variable Resistor	15A 25K ohm	TONE		

*: New Parts

RANK: Japan only

CIRCUIT BOARD

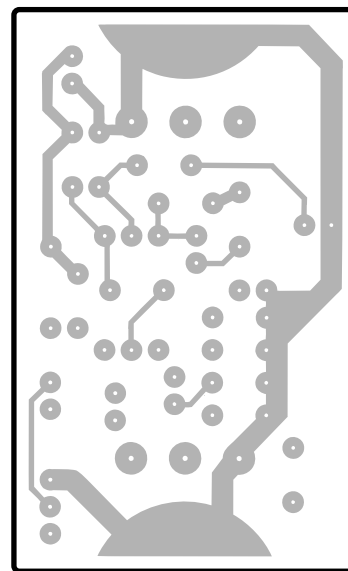
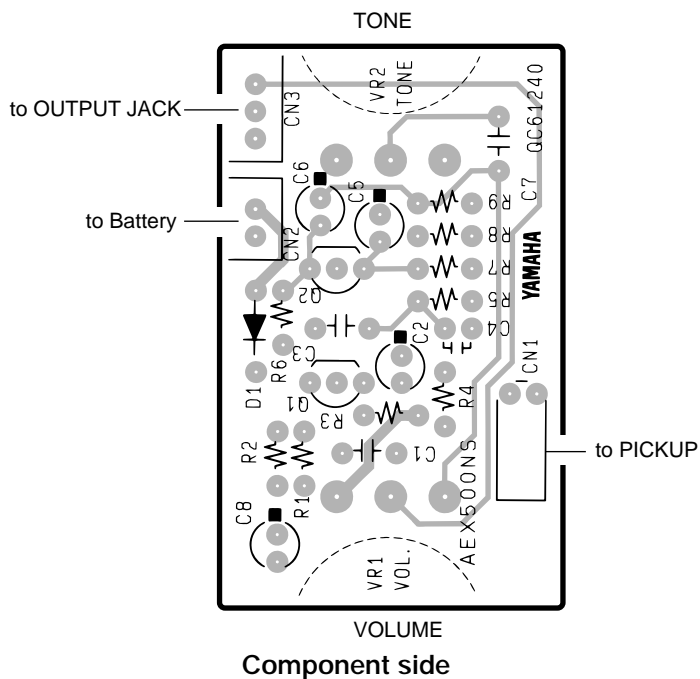

Pattern side

Note: See parts list for details of circuit board component parts.

EPA-QC59580

CIRCUIT DIAGRAM

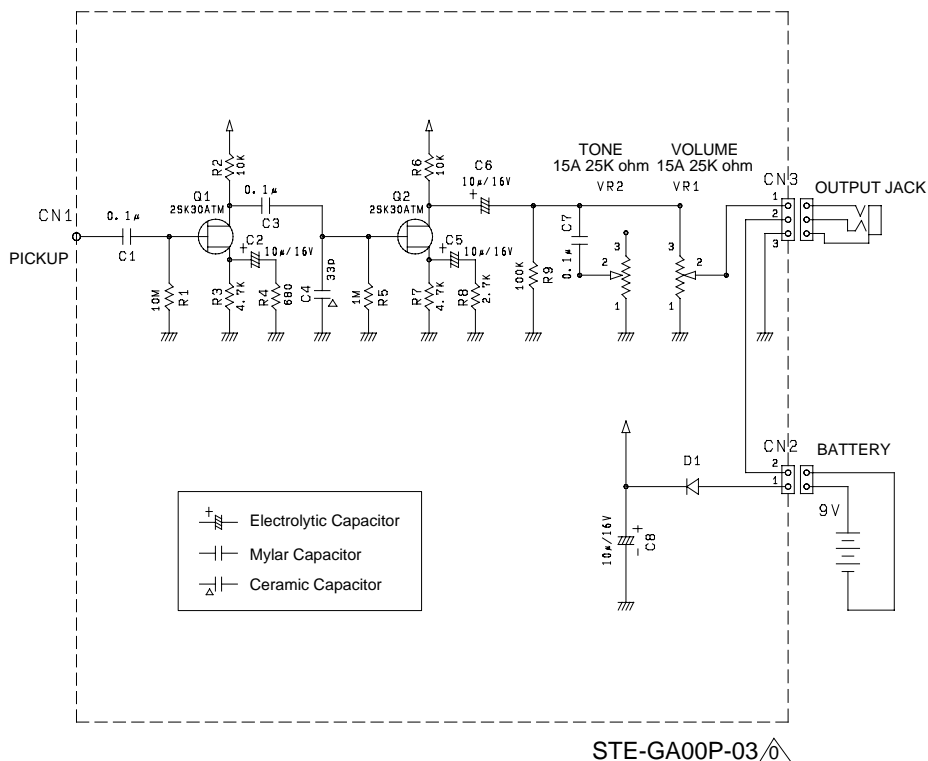

■ WIRING

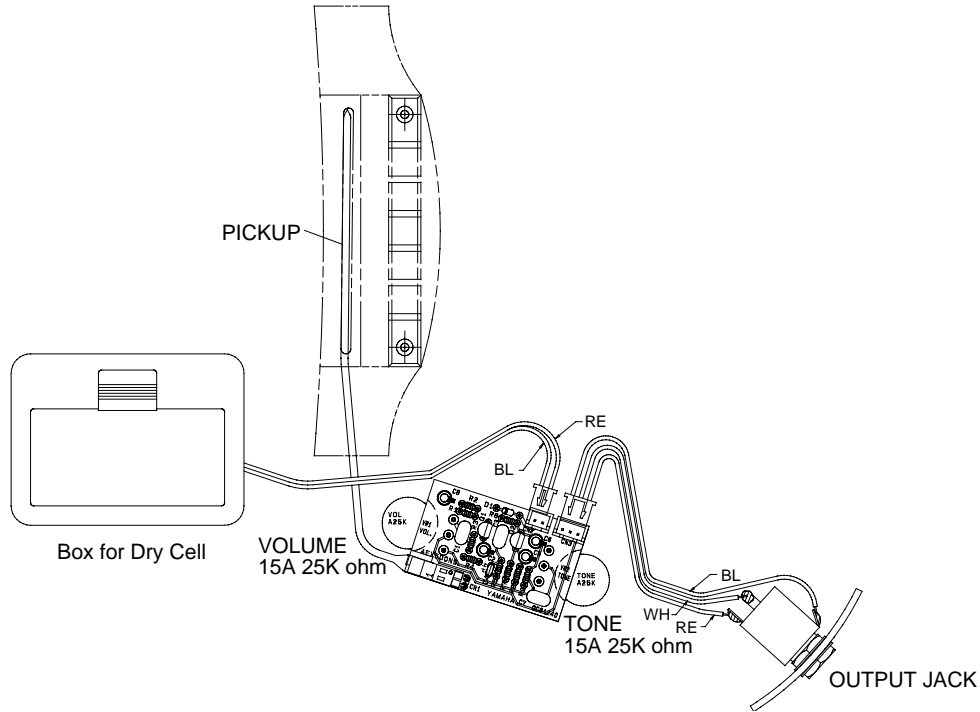

■ SPECIFICATIONS

● STANDARD SPECIFICATIONS

Scale Length 648mm
 Body-Neck Construction Bolt On
 Length 1011mm
 Width 365mm
 Net Weight 3.0kg

● COLOR

Body
 BL Black
 NT Natural
 AMT Amber Burst
 Neck
 NS Natural Satin

● BODY

Material Spruce, Alder, Maple
 Body Depth 43.9mm

● FINGERBOARD

Material Rose
 Fingerboard Width 0-F 45.0 mm, 12-F 54.5 mm
 No. of Frets 20

● NECK

Material Maple
 Neck Thickness 1-F 20.9 mm, 12-F 23.1 mm

● PARTS

Hardware Gold Plated
 Nut Bone
 Bridge Indian Rosewood
 Strings S11-S16

● CONTROLS

Volume 15A 25KΩ x 1
 Tone 15A 25KΩ x 1

● PICKUPS

Pickup B-band 29S